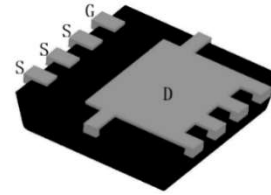

FEATURES

- Drain-Source Withstand Voltage: 40V
- Max. $R_{DS(on)}$: 4.5 m Ω @ $V_{GS}=10V$
7.1 m Ω @ $V_{GS}=4.5V$
- Automotive applications
- AEC-Q101 Qualified
- Excellent ON resistance
- General footprint package PDFN3333-8L
- 100% Rg and Avalanche tested

PRODUCT APPEARANCE

PDFN3333-8L

DESCRIPTION

The SNM044R5DRAQ is N-Channel enhancement MOS Field Effect Transistor. Uses advanced trench technology and design to provide excellent $R_{DS(ON)}$ with low gate charge. This device is suitable for use in high performance automotive DC-DC conversion, power switch and charging circuit. Standard Product SNM044R5DRAQ is in compliance with RoHS.

Applications:

- Automotive systems
- DC/DC converters
- Power supply converters circuit
- Load/Power Switching for portable device

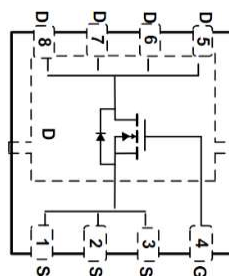
PIN CONFIGURATION

Top view

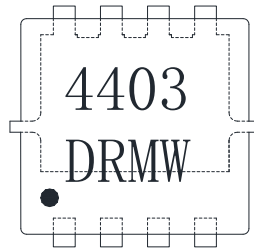
MARKING

4403 = Device Code
 DR = Special Code
 M = Month
 W = Week

LIMITING VALUES

Parameter	Symbol	Condition	Value	Unit
Drain-Source Voltage	V_{DS}		40	V
Gate-Source Voltage	V_{GS}		± 20	V
Continuous Drain Current	I_D	$T_C=25^\circ\text{C}$	83	A
		$T_C=100^\circ\text{C}$	59	A
Pulsed Drain Current ⁽³⁾	I_{DM}		198	A
Continuous Drain Current	I_D	$T_A=25^\circ\text{C}$	18	A
		$T_A=100^\circ\text{C}$	13	A
Avalanche Energy $L=0.3\text{mH}$	E_{AS}		54	mJ
Power Dissipation ⁽²⁾	P_D	$T_C=25^\circ\text{C}$	59	W
		$T_C=100^\circ\text{C}$	29	W
Power Dissipation ⁽¹⁾	P_D	$T_A=25^\circ\text{C}$	2.9	W
		$T_A=100^\circ\text{C}$	1.4	W
Operating Junction Temperature	T_J		-55 to 175	$^\circ\text{C}$
Storage Temperature Range	T_{STG}		-55 to 175	$^\circ\text{C}$

THERMAL RESISTANCE RATINGS

Single Operation					
Parameter		Symbol	Typical	Maximum	Unit
Junction-to-Ambient Thermal Resistance ⁽¹⁾	Steady State	R _{θJA}	41.8	53.0	°C/W
Junction-to-Case Thermal Resistance ⁽²⁾	Steady State	R _{θJC}	2.1	2.6	

ELECTRONICS CHARACTERISTICS

Parameter	Symbol	Conditions	Min	Typ	Max	Unit
OFF CHARACTERISTICS						
Drain-to-Source Breakdown Voltage	BV _{DSS}	V _{GS} =0 V, I _D = 250μA	40			V
Drain-to-Source Breakdown Voltage Temperature Coefficient	BV _{DSS} /T _J			19.1		mV/°C
Zero Gate Voltage Drain Current	I _{DSS}	V _{DS} =40V, V _{GS} = 0V, T _J =25°C			1	μA
		V _{DS} =40V, V _{GS} = 0V, T _J =125°C			100	μA
Gate-to-source Leakage Current	I _{GSS}	V _{DS} =0 V, V _{GS} =±20V			±100	nA
ON CHARACTERISTICS						
Gate Threshold Voltage	V _{GS(TH)}	V _{GS} =V _{DS} , I _D = 250μA	1.3	1.7	2.1	V
Threshold Temperature Coefficient	V _{GS(TH)} /T _J			-5.1		mV/°C
Drain-to-source On-resistance ⁽⁴⁾	R _{DS(on)}	V _{GS} =10V, I _D =30A		3.6	4.5	mΩ
		V _{GS} =4.5V, I _D =30A		5.4	7.1	mΩ
CHARGES, CAPACITANCES AND GATE RESISTANCE						
Input Capacitance	C _{ISS}	V _{GS} = 0V, f = 1.0MHz, V _{DS} =25V		1265		pF
Output Capacitance	C _{OSS}			280		
Reverse Transfer Capacitance	C _{RSS}			20		
Total Gate Charge ⁽⁵⁾	Q _{G(TOT)}	V _{GS} =10V, V _{DS} = 32V, I _D = 30A		19.3		nC
Gate-to-Source Charge ⁽⁵⁾	Q _{GS}			3.5		
Gate-to-Drain Charge ⁽⁵⁾	Q _{GD}			3.1		

Parameter	Symbol	Conditions	Min	Typ	Max	Unit
Gate Resistance	R_g	$f=1\text{MHz}$		2.1		Ω
SWITCHING CHARACTERISTICS ⁽⁵⁾						
Turn-On Delay Time	$t_d(\text{ON})$	$V_{GS}=10\text{V},$ $V_{DS}=32\text{V},$ $I_D=30\text{A}, R_G=5\Omega$		4.0		ns
Rise Time	t_r			24.8		
Turn-Off Delay Time	$t_d(\text{OFF})$			21.8		
Fall Time	t_f			15.6		
Body Diode Reverse Recovery Time	t_{rr}	$I_F=30\text{A},$ $dI/dt=100\text{A}/\mu\text{s}$		24.0		ns
Body Diode Reverse Recovery Charge	Q_{rr}	$I_F=30\text{A},$ $dI/dt=100\text{A}/\mu\text{s}$		6.4		nC
BODY DIODE CHARACTERISTICS						
Forward Voltage ⁽⁴⁾	V_{SD}	$V_{GS}=0\text{V}, I_S=30\text{A}$	0.5	0.8	1.2	V

($T_J=25^\circ\text{C}$, unless otherwise noted.)

Note:

- (1) FR-4 board (38mm×38mm×t1.6mm, 70 μm Copper) partially covered with copper (645mm² area). The power dissipation P_{DSM} is based on Junction-to-Ambient thermal resistance value and the $T_{J(\text{MAX})}=175^\circ\text{C}$. The value is only for reference, any application depends on the user's specific board design.
- (2) The power dissipation P_D is based on $T_{J(\text{MAX})}=175^\circ\text{C}$, using junction-to-case thermal resistance, and is more useful in setting the upper dissipation limit for cases where additional heat sinking is used.
- (3) Repetitive rating, pulsed, duty cycle ~1%, keep initial $T_J=25^\circ\text{C}$, the maximum allowed junction temperature of 175 $^\circ\text{C}$.
- (4) The static characteristics are obtained using ~380 μs pulses, duty cycle ~1%.
- (5) The parameter is not subject to production test – verified by design / characterization.

TYPICAL CHARACTERISTICS

Ta=25°C, unless otherwise noted.

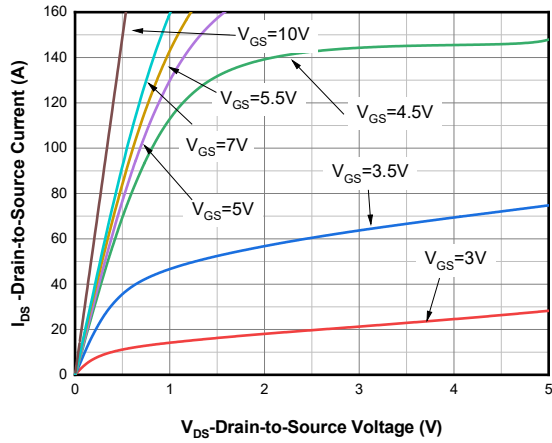

Output Characteristics ⁽⁴⁾

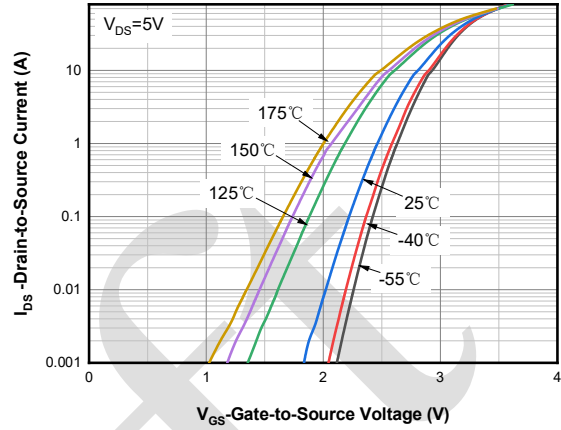

Transfer Characteristics ⁽⁴⁾

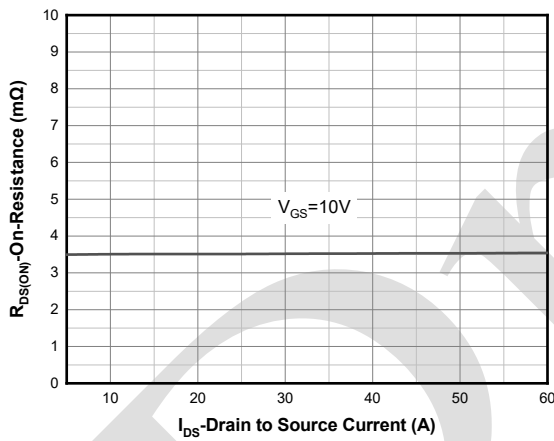

On-Resistance vs. Drain Current ⁽⁴⁾

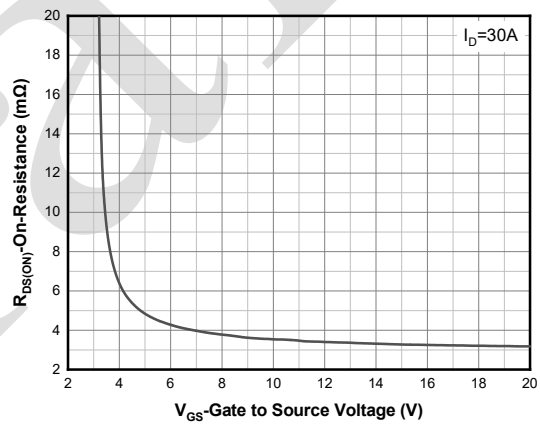

On-Resistance vs. Gate-to-Source Voltage ⁽⁴⁾

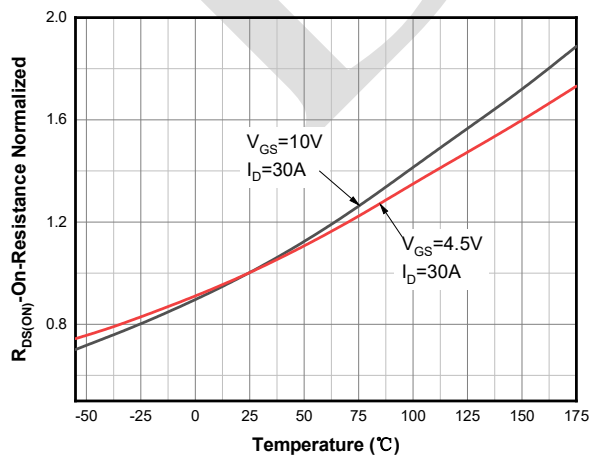

On-Resistance vs. Junction Temperature ⁽⁴⁾

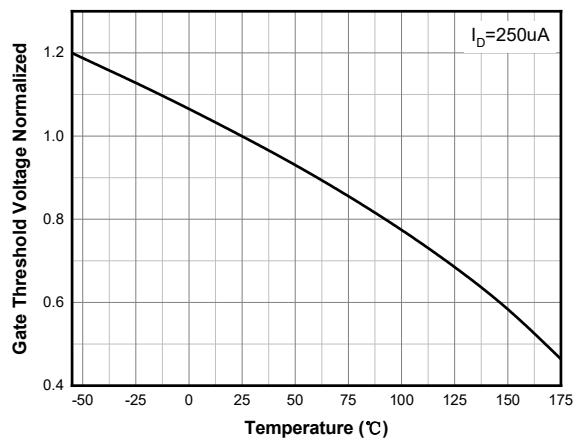

Threshold Voltage vs. Temperature

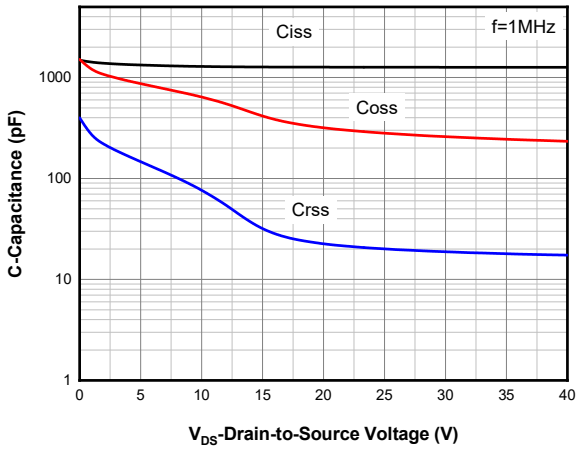
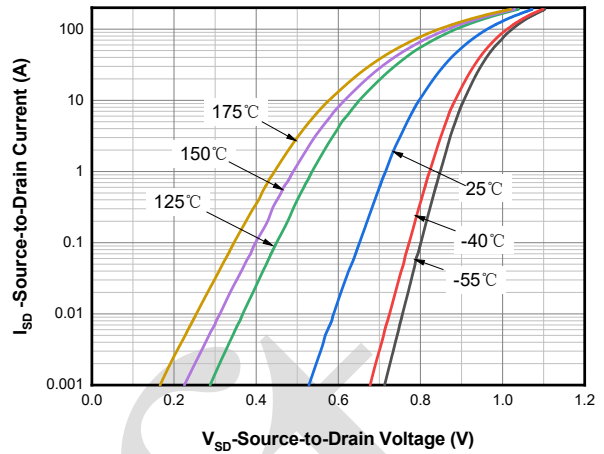
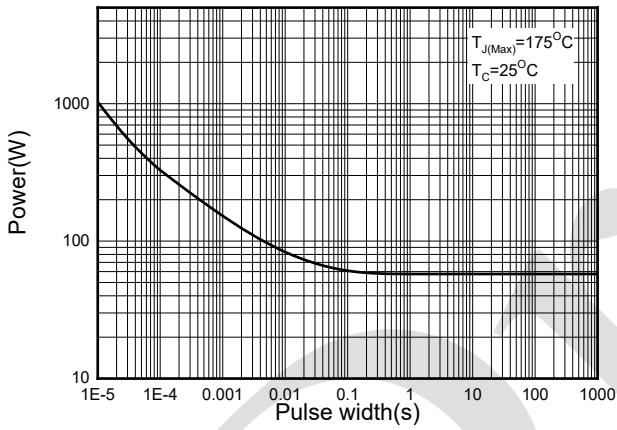
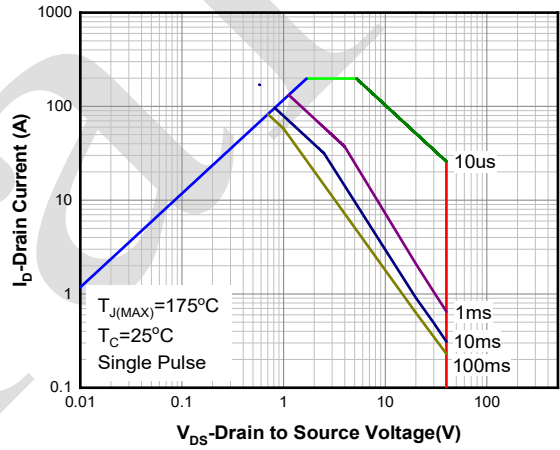
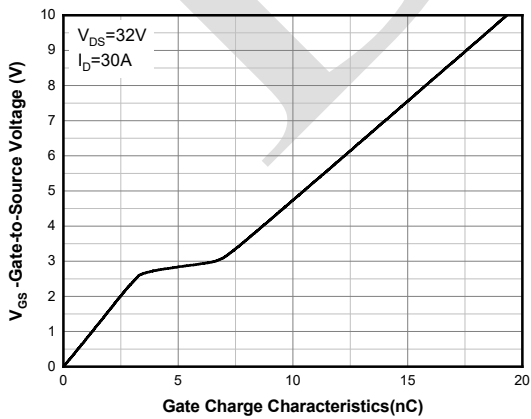
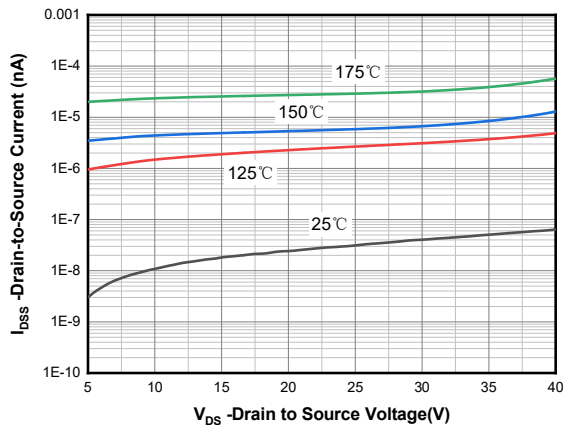

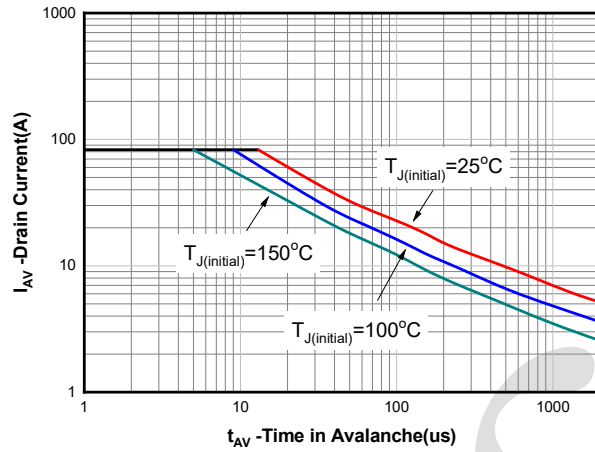
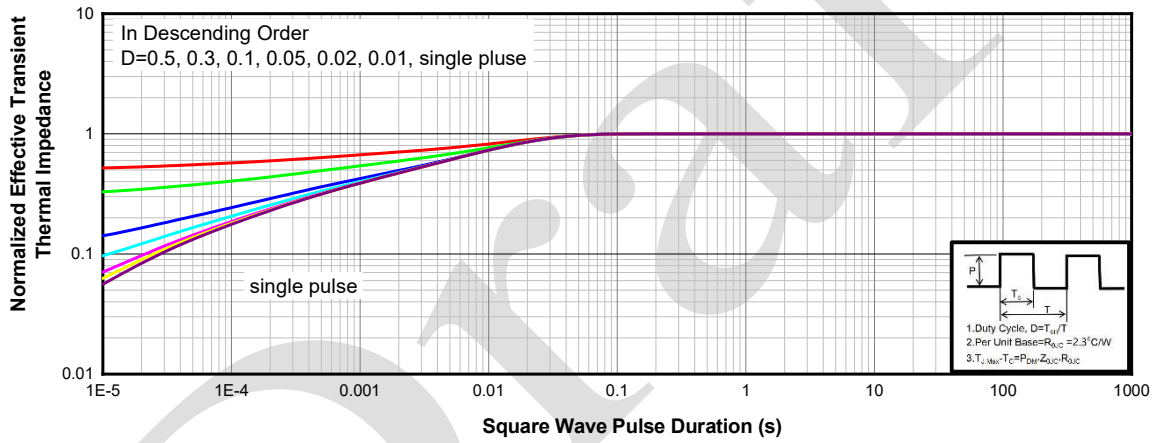
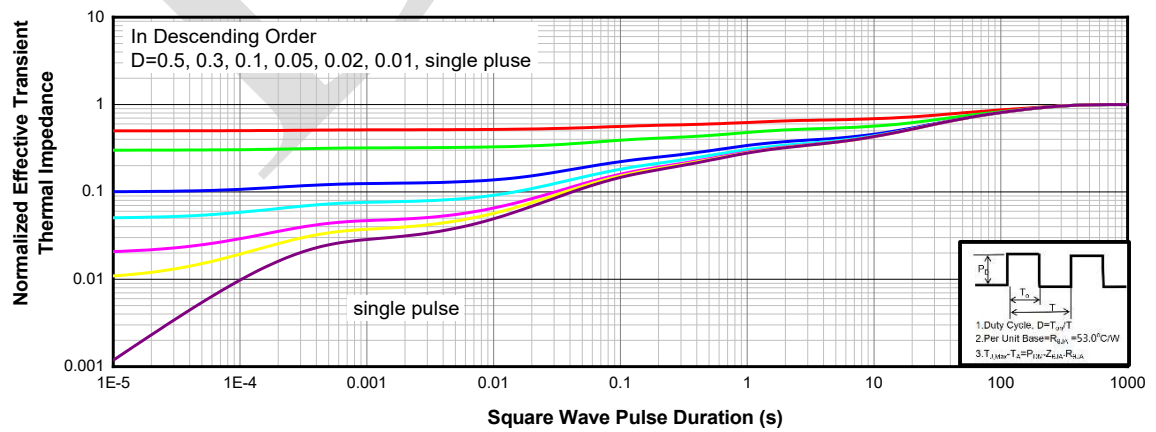
Capacitance

Body Diode Forward Voltage ⁽⁴⁾

Single Pulse power

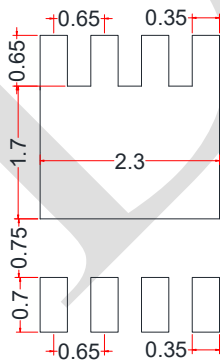
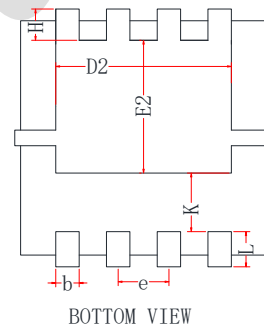
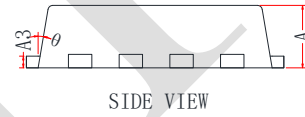
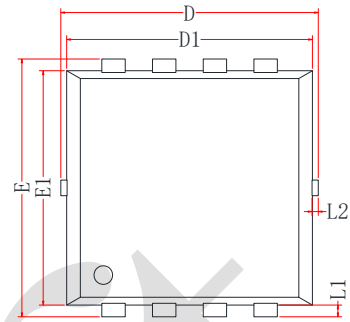
Safe Operating Area

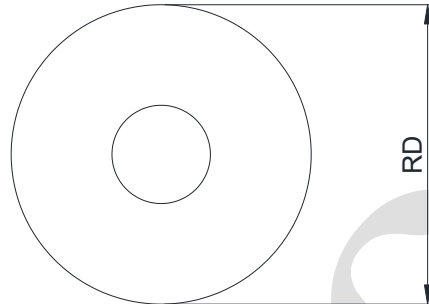
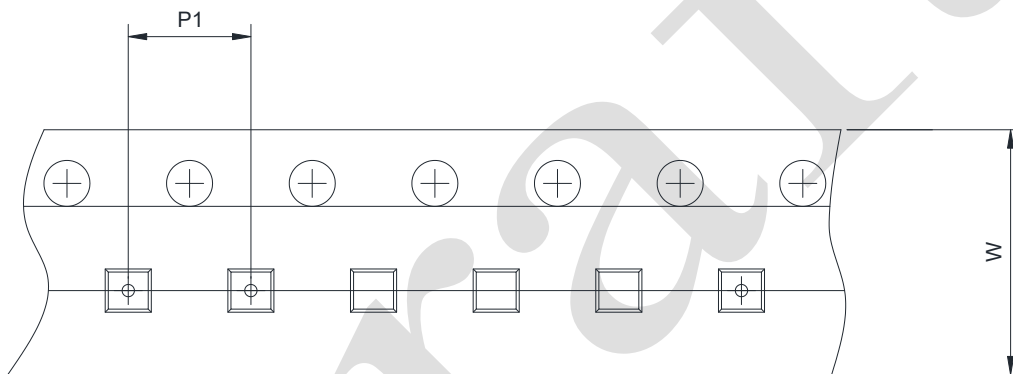
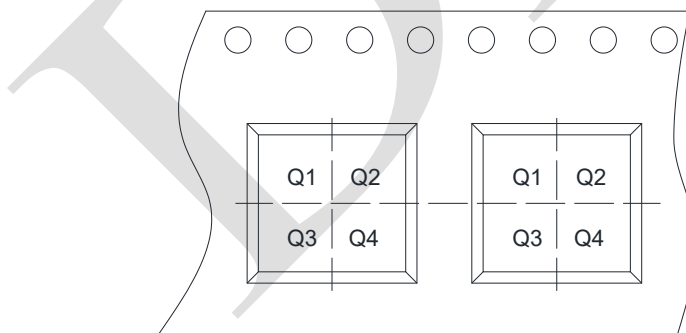
Gate Charge Characteristics

Drain Current vs. Drain Voltage

Avalanche characteristics

Transient Thermal Response (Junction-to-Case)

Transient Thermal Response (Junction-to-Ambient)

PDFN3333-8L DIMENSIONS
PACKAGE SIZE

Symbol	Min.	Typ.	Max.
A	0.70	0.80	0.90
A3	0.14	0.15	0.20
b	0.25	0.30	0.39
D	3.10	3.30	3.50
D1	3.05	3.15	3.25
D2	2.15	2.25	2.35
e	0.55	0.65	0.75
E	3.10	3.30	3.50
E1	2.90	3.00	3.10
E2	1.60	1.70	1.80
H	0.25	0.40	0.55
K	0.65	0.75	0.85
L	0.30	0.45	0.60
L1	0.05	0.15	0.25
L2	-	-	0.15
θ	8 °	10 °	12 °



TAPE AND REEL INFORMATION
Reel Dimensions

Tape Dimensions

Quadrant Assignments For PIN1 Orientation In Tape

User Direction of Feed

RD	Reel Dimension	<input type="checkbox"/> 7inch	<input checked="" type="checkbox"/> 13inch		
W	Overall width of the carrier tape	<input type="checkbox"/> 8mm	<input checked="" type="checkbox"/> 12mm		
P1	Pitch between successive cavity centers	<input type="checkbox"/> 2mm	<input type="checkbox"/> 4mm	<input checked="" type="checkbox"/> 8mm	
Pin1	Pin1 Quadrant	<input checked="" type="checkbox"/> Q1	<input type="checkbox"/> Q2	<input type="checkbox"/> Q3	<input type="checkbox"/> Q4

ORDERING INFORMATION

TYPE NUMBER	PACKAGE	PACKING
SNM044R5DRAQ-8/TR	PDFN3333-8L	Tape and reel

PDFN3333-8L is packed with 5000 pieces/disc in braided packaging.

Important statement

SIT reserves the right to change the above-mentioned information without prior notice.

REVISION HISTORY

Version number	Datasheet status	Revision date
V0.1	Draft version.	July 2024

Draft